



The manufacturing tradition for door closures that last for years...



The CLASSIC line offers screen and open frame roller shutters, ideal for protecting domestic, commercial and industrial closures.

A range of products made from high quality steel or special aluminium alloys, certified and verified by ISEA.

Extremely secure and elegant closures (installed in accordance with UNI safety standards), ideal for small and large openings, they can be operated either manually or electrically depending on size.

Screen roller shutters

Extremely functional closures that guarantee operating safety and efficiency.

Various finishes and the possibility of inserting transparent inspection windows for maximum personalisation.

Roller grilles

Structural systems made using profiles with high-resistance shapes and assembled using patented connecting joints or coupling links.

The refined BITUBO version, with nylon sliding shoes, is ideal for single span closures for the modern retail distribution sector.

Micro-perforated roller shutters

The elegant TRASPAR micro-perforated version is ideal for applications that need a constant visual of the inside area. Suitable for all sizes, they are widely used in commercial applications and security closures that require a good degree of ventilation.

Insulated roller shutters

Ideal for increasing thermal and acoustic insulation, for special applications in the industrial sector.

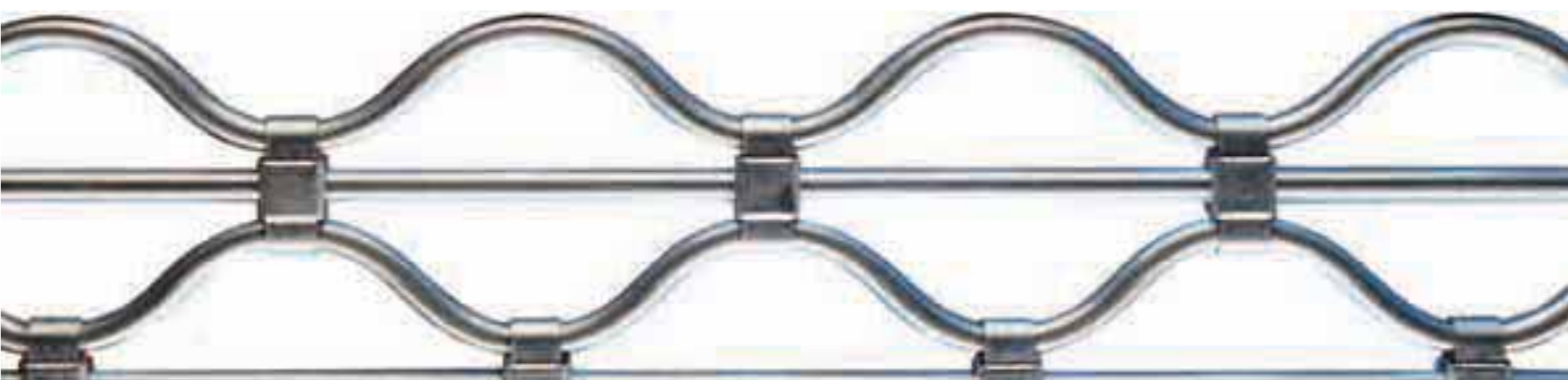



CHIUDE CON SICUREZZA

ISEA s.r.l.

40050 Funo di Argelato Bologna (Italia)

via Galletti, 9 Tel. (+39) 051/862004 r.a. Fax (+39) 051/861404

email: info@iseaitaly.com www.iseaitaly.com



ROLLER GRILLES
SCREEN SHUTTERS
INSULATED SHUTTERS
COLLAPSIBLE GATES

Le chiusure di sicurezza hanno trovato il loro standard:
un giusto equilibrio di qualità, costi contenuti e servizio.

Security closures have set their own standard; a perfect
balance of high quality, low cost and service.
Structures designed, manufactured and assembled to
last, thanks to the quality and the dimensions of the
materials used; consolidated tradition combined with
the most modern production technologies allow us to
offer reliable products, distributed through a widespread
sales and service network in Italy and abroad. A
dynamic production concept organised for achieving
goals fast and customer-oriented marketing to satisfy
even the most demanding requirements of the sector.

Conforms with UNI norm EN 13241-1 

Vendor's stamp

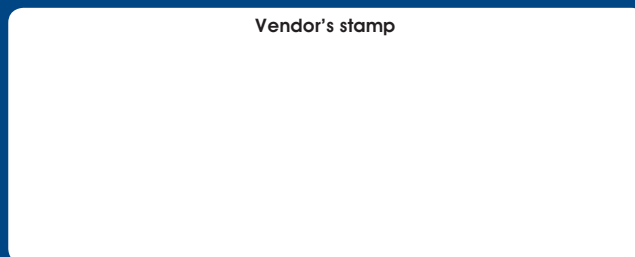

The data contained in this leaflet are not binding.
ISEA can modify them at any time, with the exception of the main features.

CLASSIC

Screen, insulated and open-frame shutters

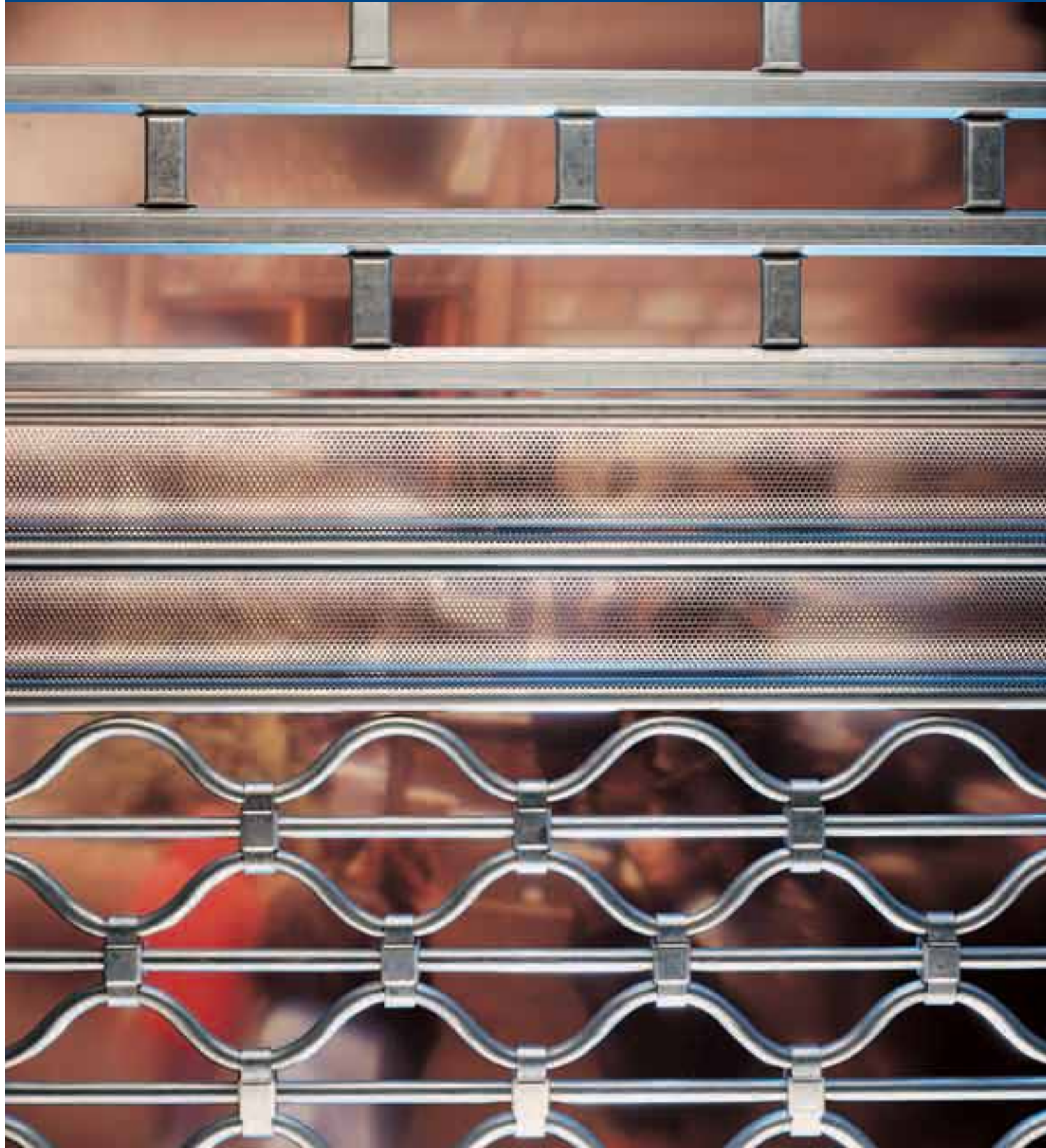



CLASSIC

The safety of ISEA roller shutters is certified

Safety requirements and performance characteristics in compliance with standard EN 12341-1.

ISEA roller doors are safe in every opening and closing stage, both motor-driven and manual. The solutions proposed have been tested by a special external committee before being put onto the market.

Therefore, it is a certified product.

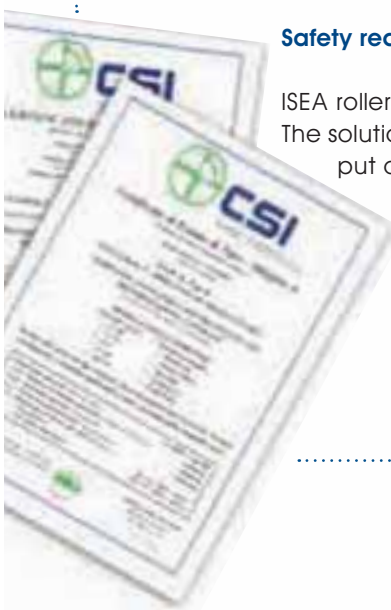

Screen shutters

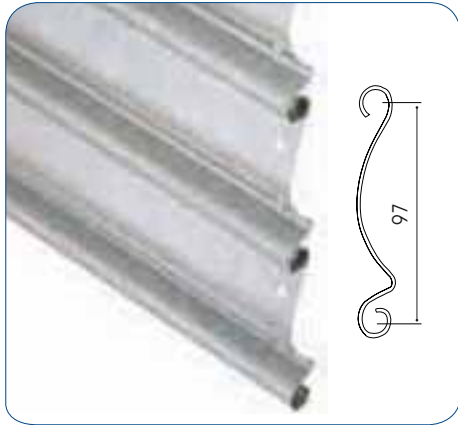

P97
The specially shaped and reinforced profile contributes to give additional rigidity to the single wall facing for secure installations.



The anti-tear bracket guarantees strong fastening to the guides especially during strong winds.

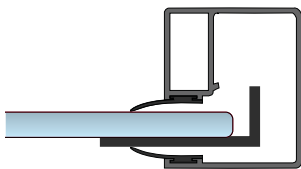

P97 TRASPAR
The micro-perforated profile allows internal ventilation making it ideal for applications requiring visibility and air recycling together with excellent security.

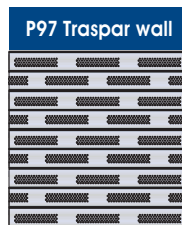
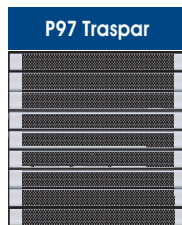

Computerized micro-hole layout
A new production concept that enables us to program micro-perforated and blind spaces.

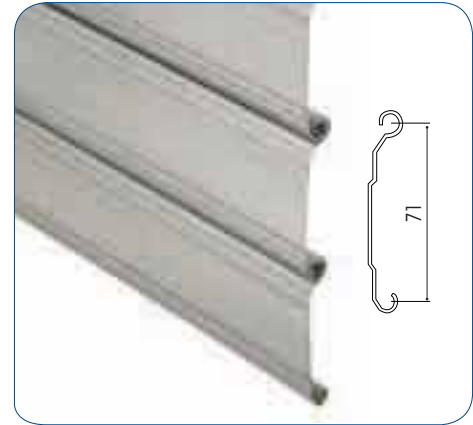

P71
Single wall profile for small or medium sized shutters. Gives the facing a compact and uniform look. Reduced roll-up encumbrance.

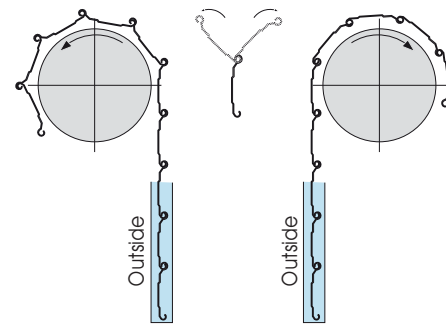

The profile occupies reduced upper space with the possibility of rolling up from both sides.



P97



P97 Traspar



P115 Traspar

Insulated shutters

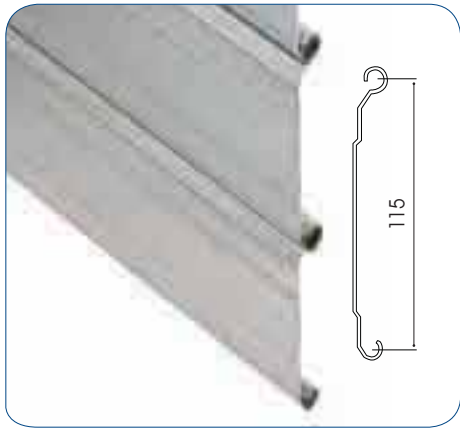

P115

The single wall profile for traditional closures. Contributes to giving the facing a compact and uniform look.

Optional:

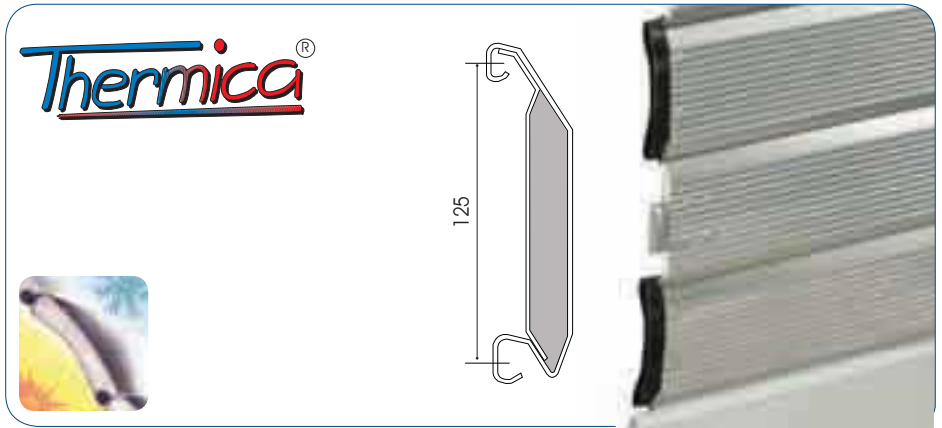
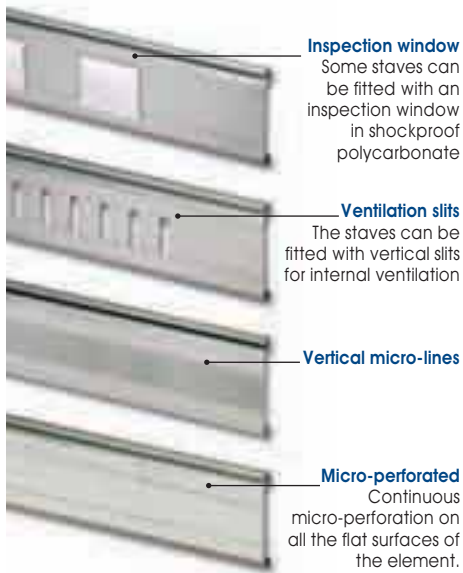

THERMICA

System with double walls and inner insulating material. Gives the facing excellent rigidity, protection against intrusion and helps to increase the thermal insulation between inside and outside.

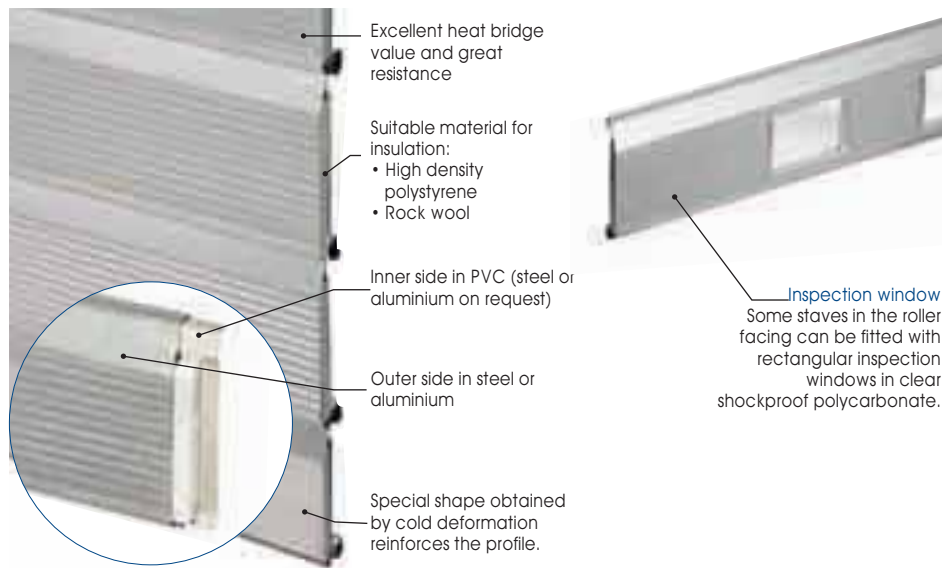

P97 + P97 Traspar

THERMICA

THERMICA





Roller grilles



BITUBO

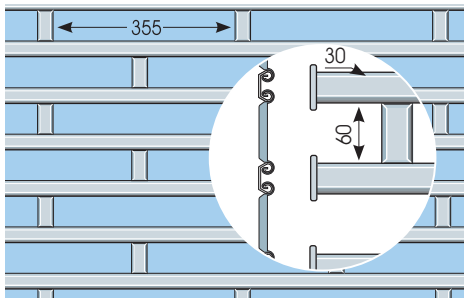

TUBOLUX

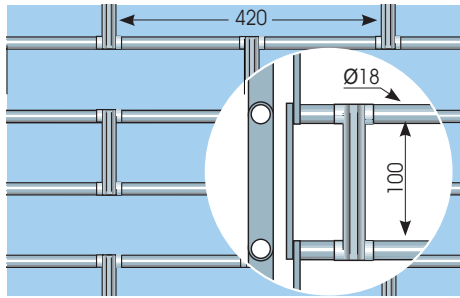

TUBONDA N-R

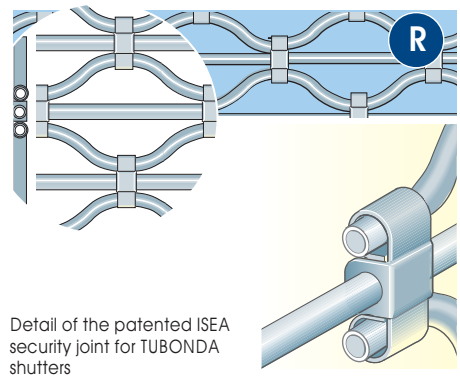
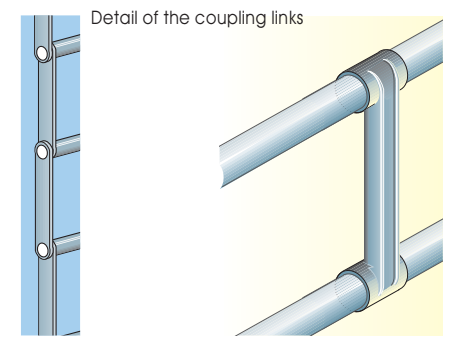
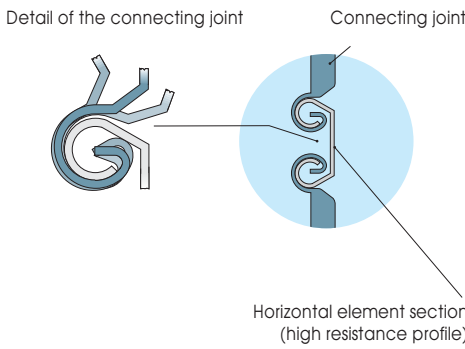
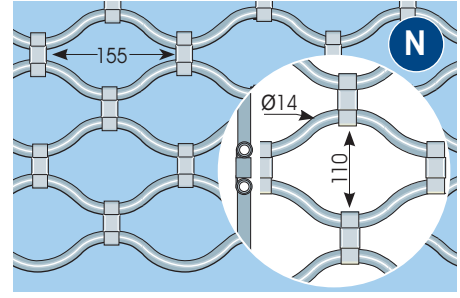

BITUBO



TUBONDA R



Accessories

Suitable guides



EVOLUTION® guide with seals

An advanced profile processing system is used to obtain steel guides complete with seals and special shaping for fitting all fastening systems.



Storm-proof guides in extruded aluminium

A reinforced shape ready to fit the storm-proof system. Complete with seals, special fixing brackets and nylon skate.



Simple guide

Guides for simple installations with limited encumbrance. Used with specific shutter profiles.

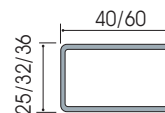
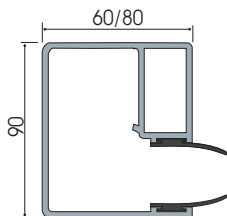
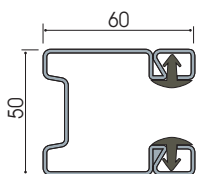

End profiles

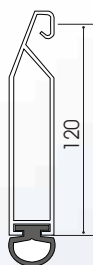

SP 120

An end profile made from reinforced extruded profile ready for fitting ground impact dampening rubber pads.

SP 105

A raw steel reinforced end profile ready for fitting ground impact dampening rubber pads.



Production materials and finishes

STEEL FINISHES	P71	P97 P97 TRASPAR	P115 P115 TRASPAR	THERMICA	BITUBO	TUBOLUX	TUBONDA N-R
galvanised steel	●	●	●	●	●	●	●
pre-painted steel	●	●	●	●	●	●	●
stainless steel	●	●	●	●	●	●	●
special aluminium alloy	●	●	●	●	●	●	●

● standard ● on request ● not available